

Anordnungsvarianten und Verschraubungspositionen beim Schwerlastauszug DC2307619-863

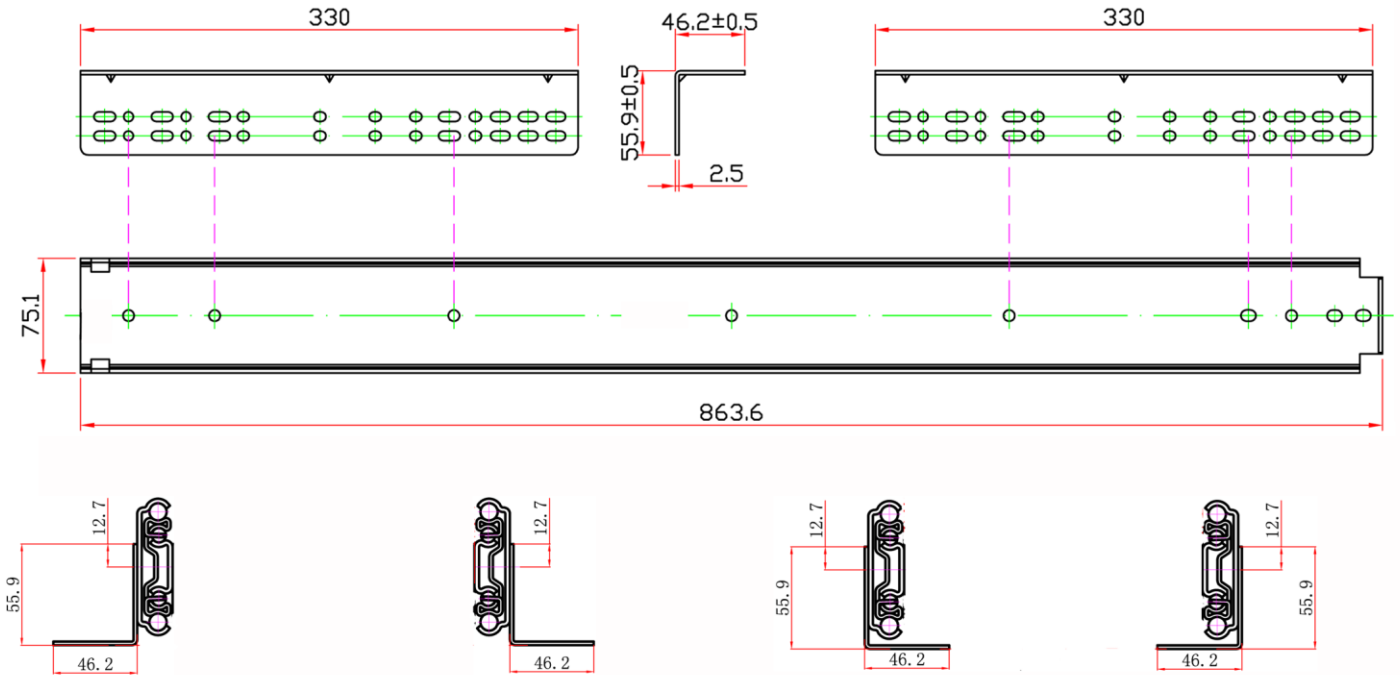

Montagewinkel Bodenmontage



Montagewinkel Plattformmontage

