

Anordnungsvarianten und Verschraubungspositionen beim Schwerlastauszug DCL2307619-1625

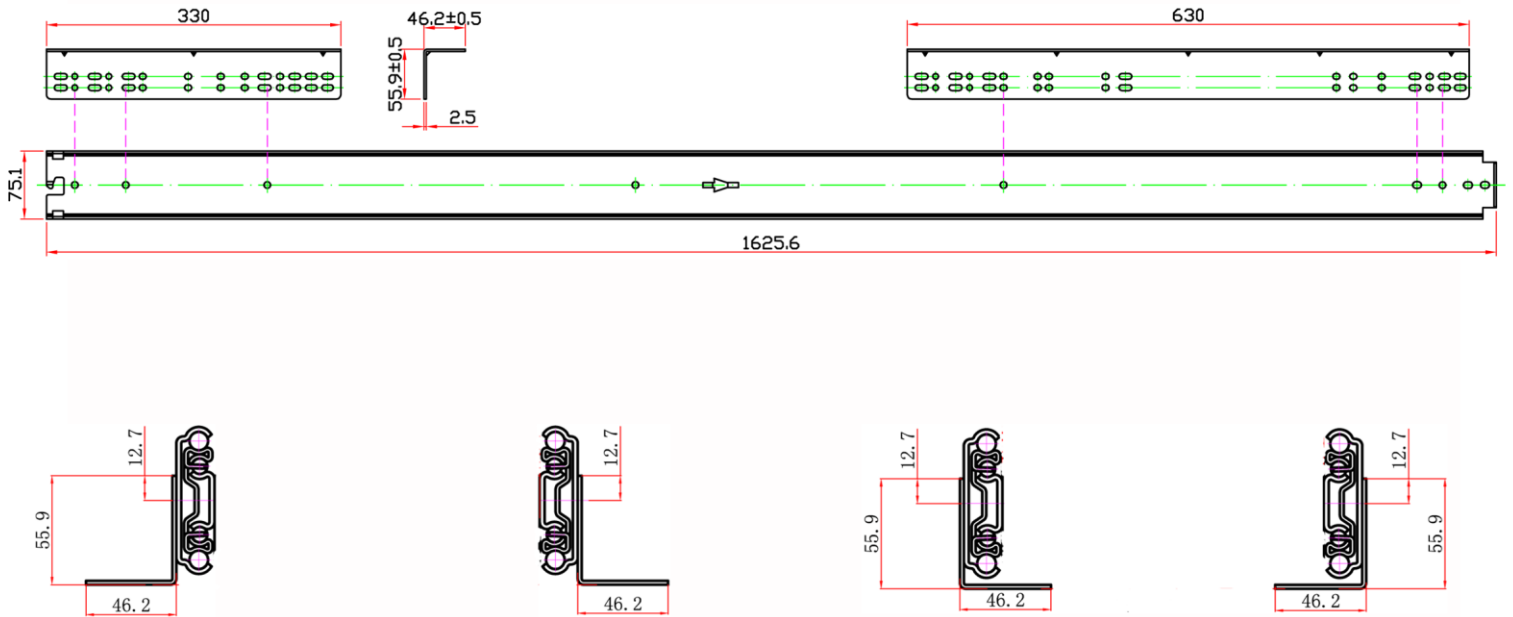

Montagewinkel Bodenmontage



Montagewinkel Plattformmontage

