

Anordnungsvarianten und Verschraubungspositionen beim Schwerlastauszug DCL2307619-1829

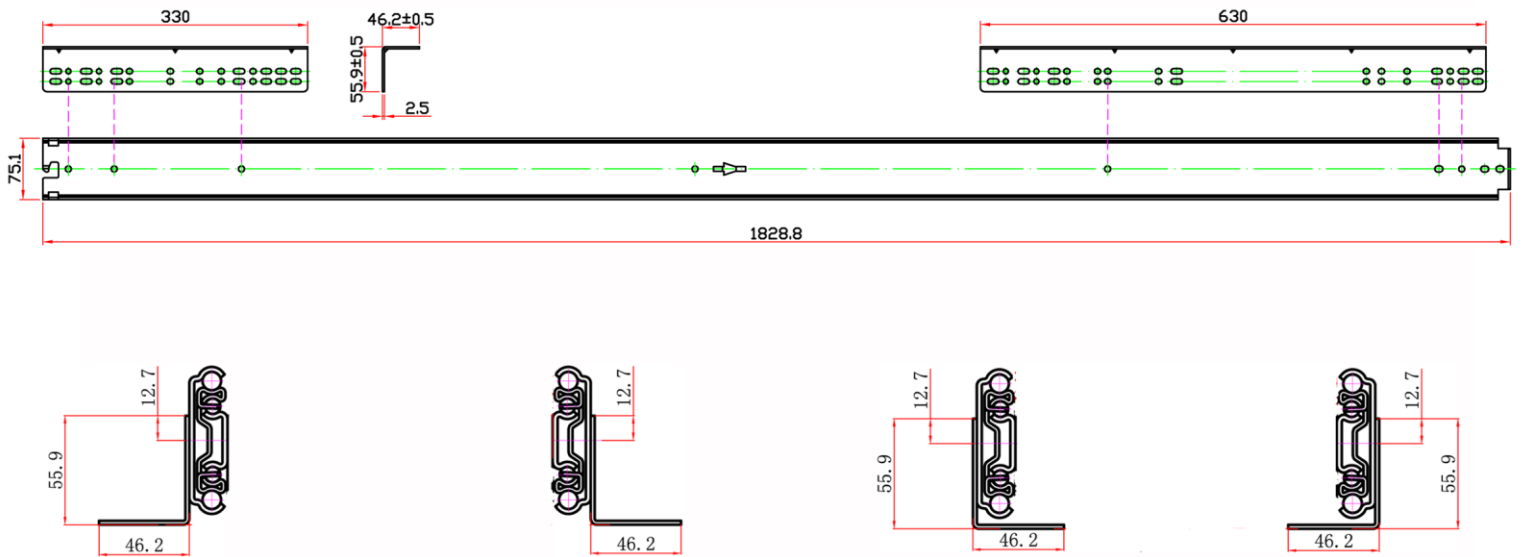

Montagewinkel Bodenmontage



Montagewinkel Plattformmontage

