

# Anordnungsvarianten und Verschraubungspositionen beim Schwerlastauszug DCL2307619-609

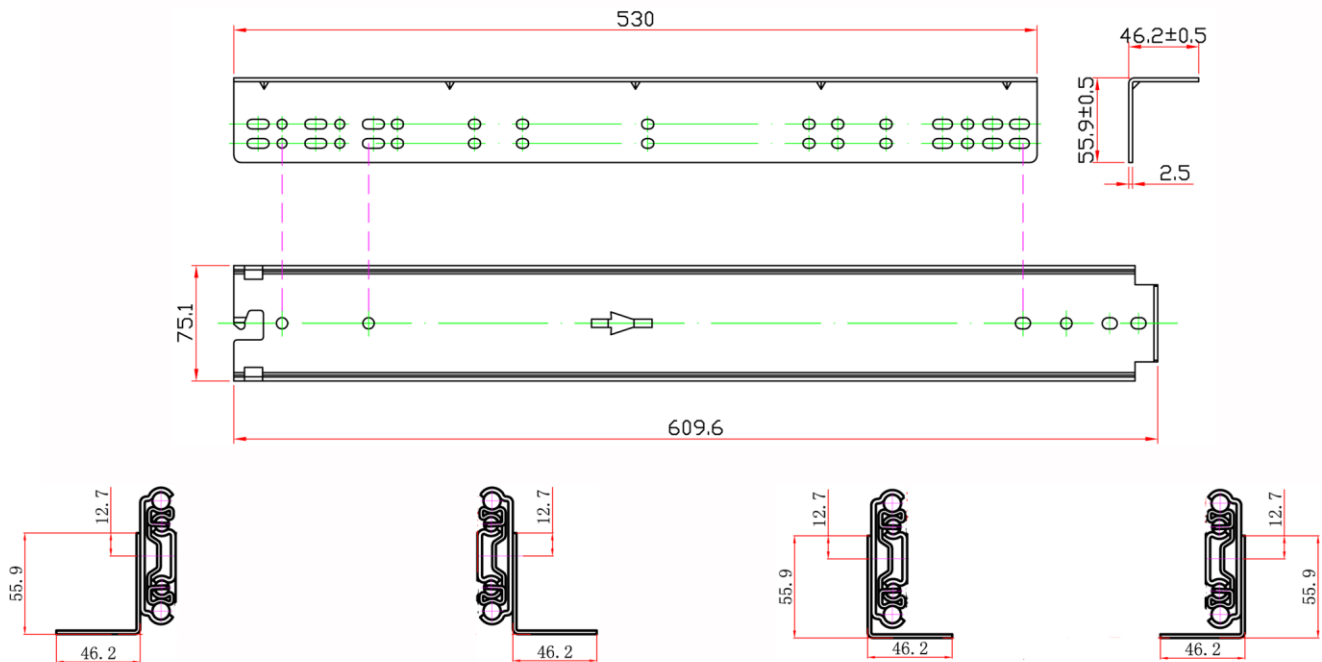

## Montagewinkel Bodenmontage



## Montagewinkel Plattformmontage

